

图 5

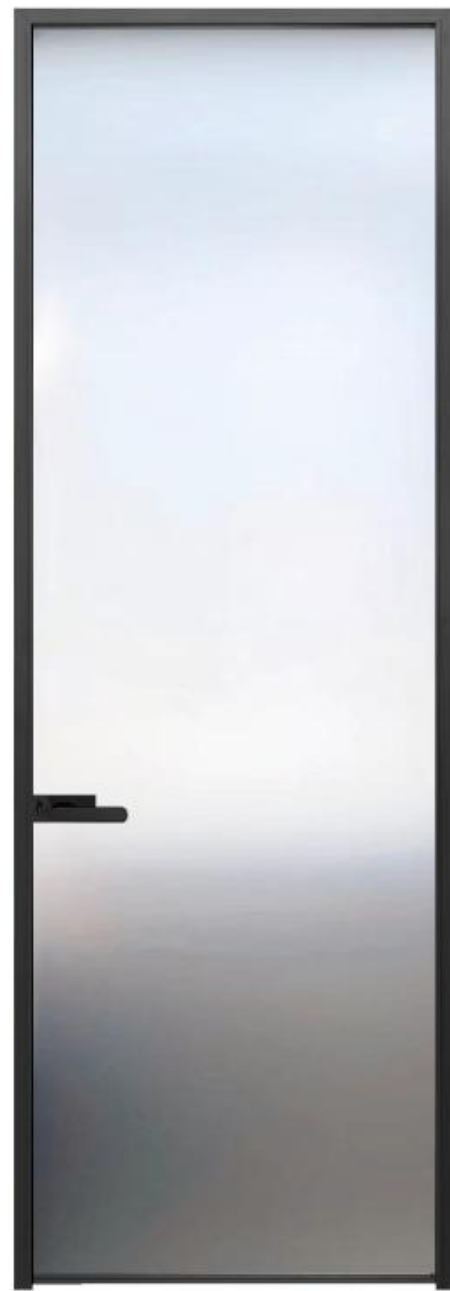



Aluminum color



LBK-01



LBK-02



LBK-03



LBK-04



LBK-05



LBK-06



LBK-07

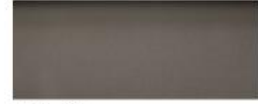

LBK-08



LBK-09



LBK-10



LBK-11



LBK-12



LBK-13

Panel: clear glass



TMBL-01

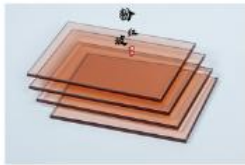

TMBL-02

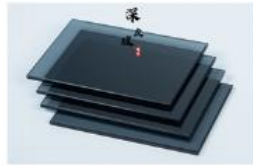

TMBL-03

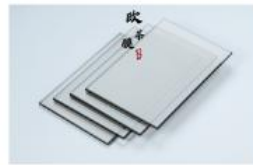

TMBL-04

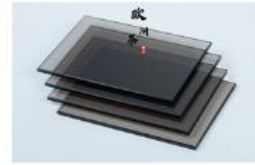

TMBL-05

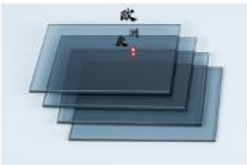

TMBL-06

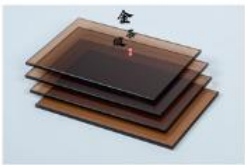

TMBL-07

# Door cover-single door opening

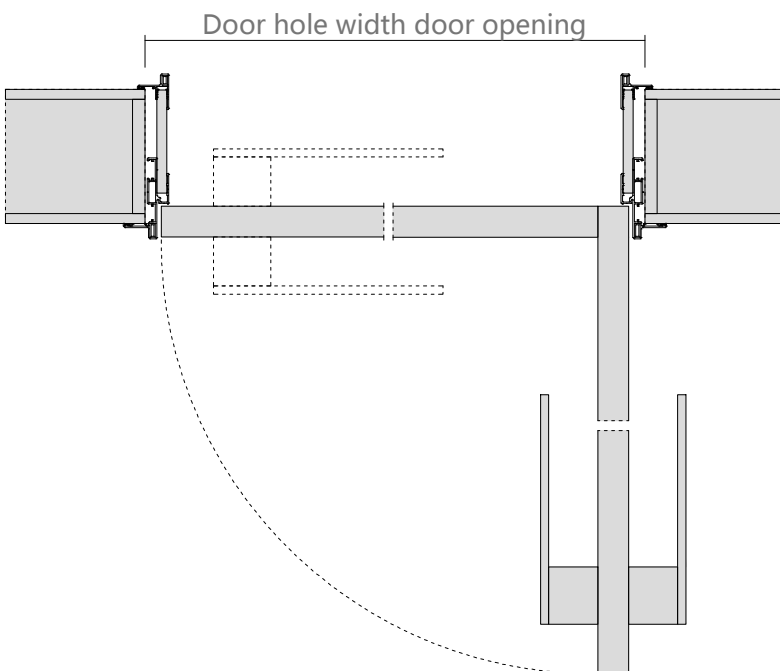
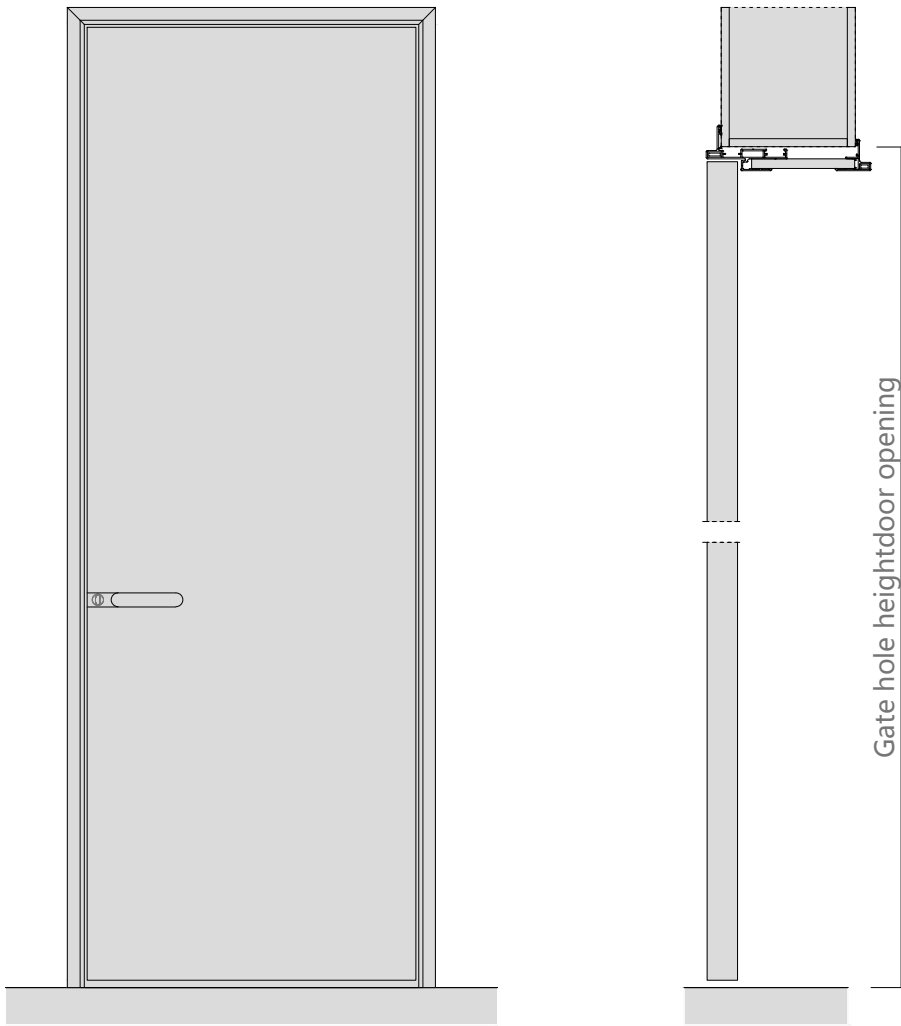

Door hole opening width  
Standard size (in mm): 790 / 890 / 990

Gate hole opening height  
Standard size (in mm):  
2050/2150/2250/2350/2450/2550/2650/2750

Wall thickness  
Standard size (in mm): 100-300

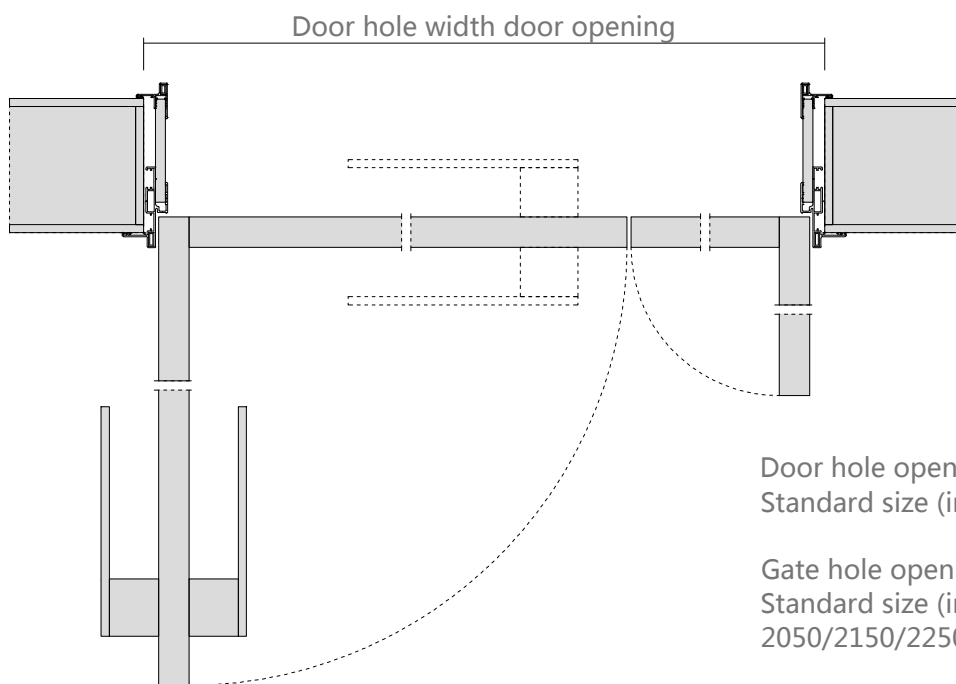
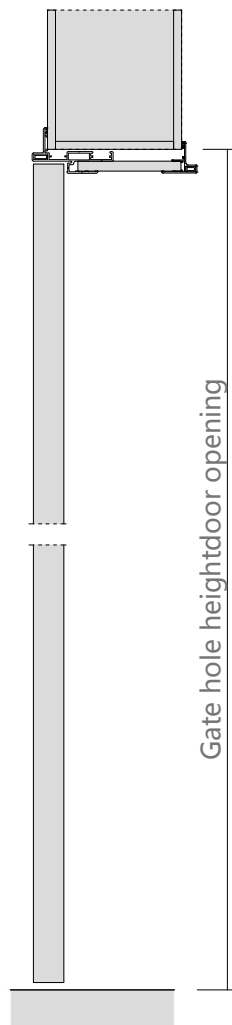
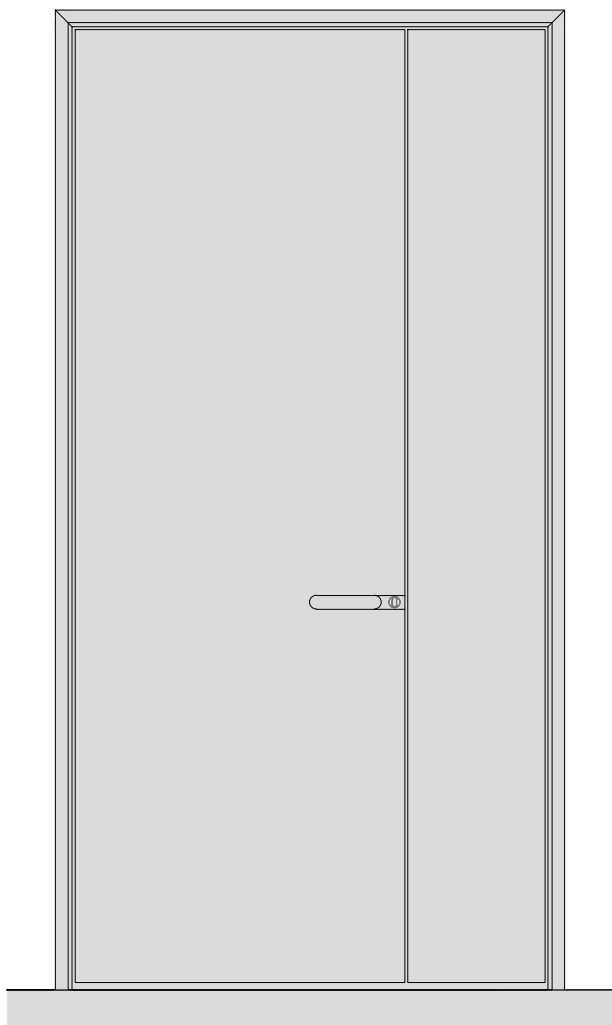

Door hole opening width  
Standard size (in mm): 1090 / 1190 / 1290 /1390/1490

Gate hole opening height  
Standard size (in mm):  
2050/2150/2250/2350/2450/2550/2650/2750

Wall thickness  
Standard size (in mm): 100-300

# Door cover-open the door

---

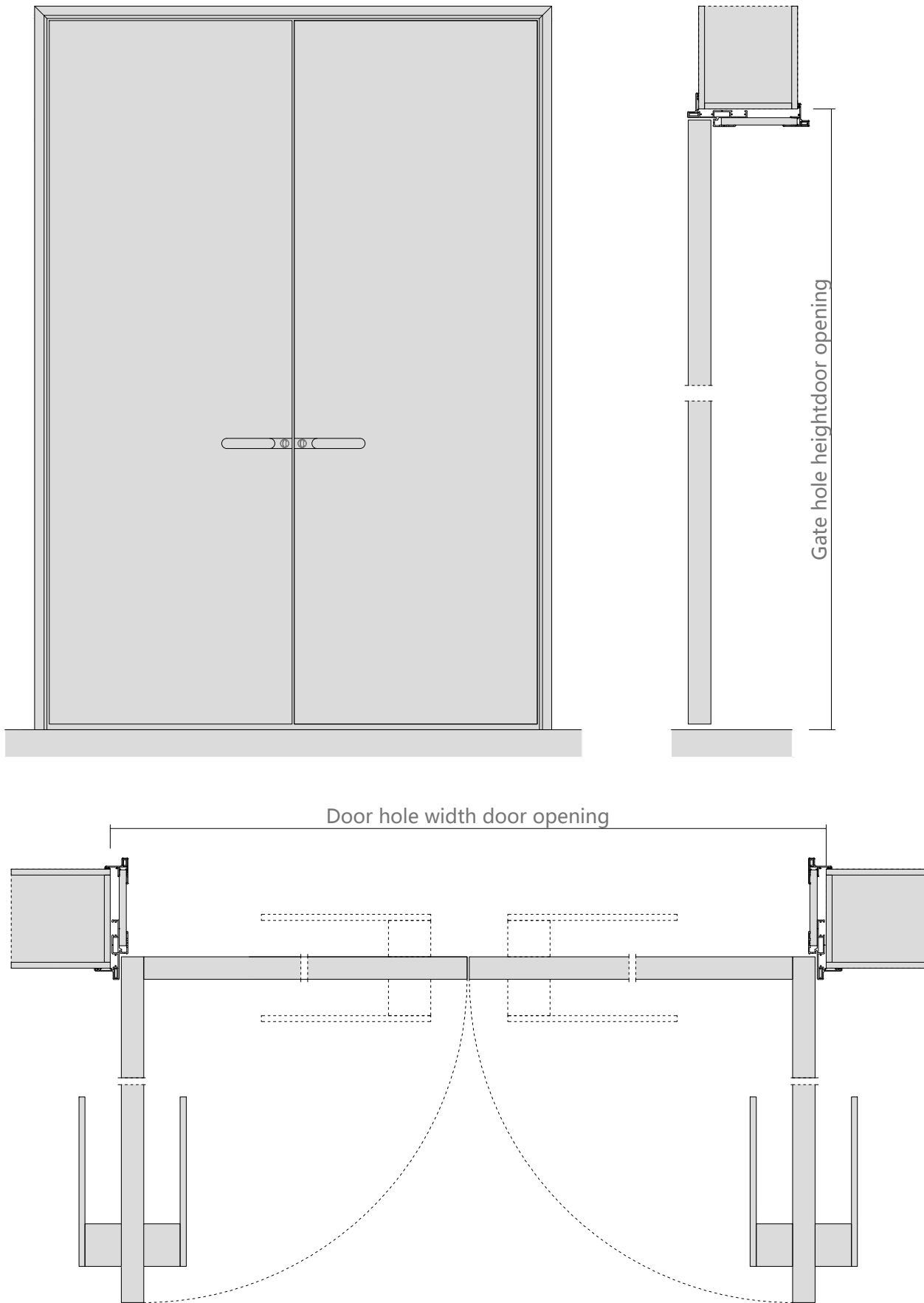

Door hole opening width  
Standard size (in mm): 1560/ 1760 / 1860 /1960

Wall thickness  
Standard size (in mm): 100-300

Gate hole opening height  
Standard size (in mm): 2050/2150/2250/2350/2450/2550/2650/2750

Relove system inside the door

---

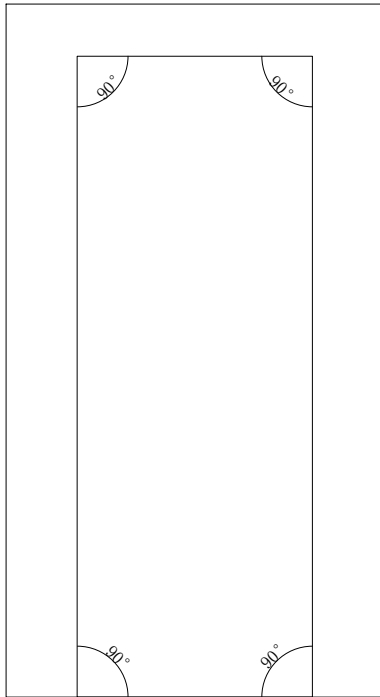

Opening production requirements :

- 1 The opening is 90 degrees horizontal and vertical
- 2 European pine board and joinery board with base ( 15mm or 18mm thick )
- 3 Base plate and wall stack foam bond, expansion nail fixed base plate, must be firm ( 22 pins / openings )

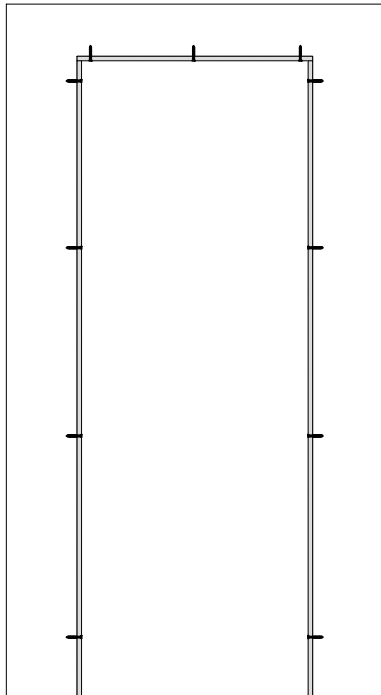

# Schematic diagram of hole

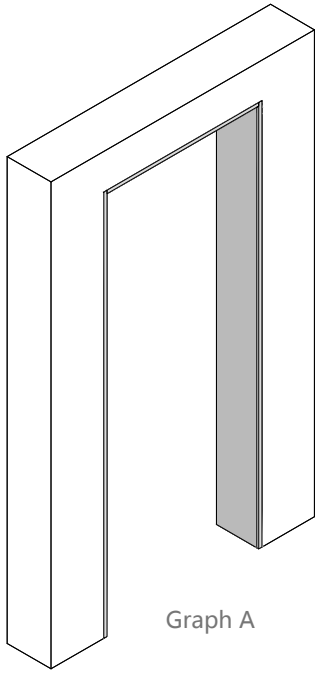

## Schematic diagram of the hole opening section

- 1 White, drywall,wallpaper,wall cloth,latex paint wall ( Figure A )
- 2 Wall board wall ( Figure B )

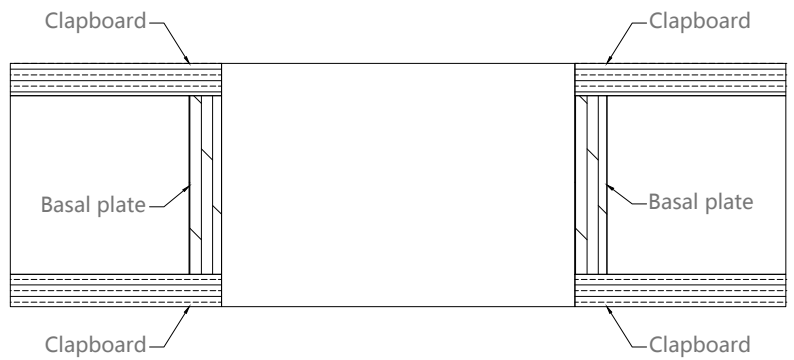
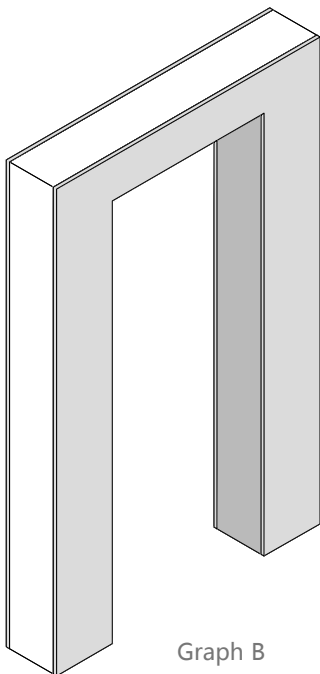

Double panel

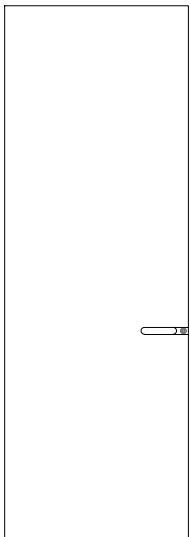

Pure (single door opening)

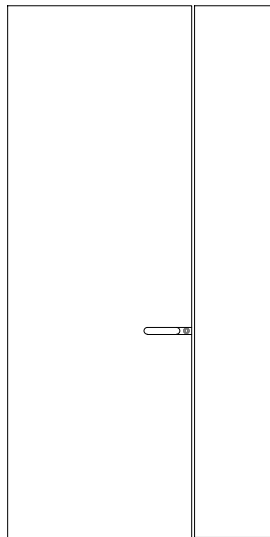

Pure (Panax notoginseng Gate)

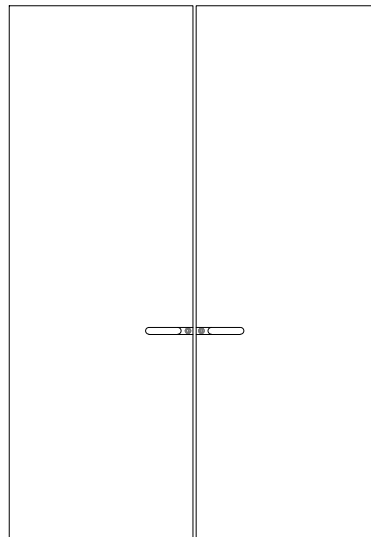

Pure (Open)

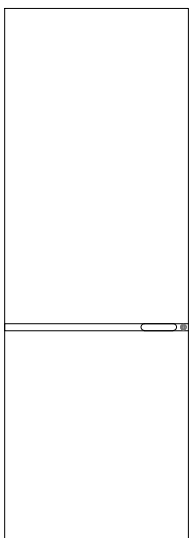

Change B (Single Open)

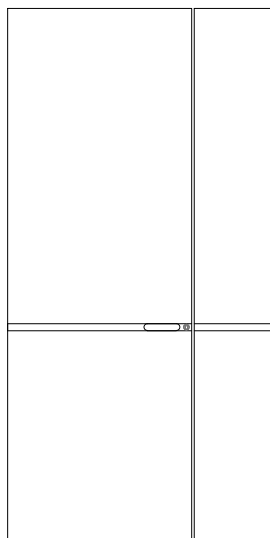

Change B (March 37)

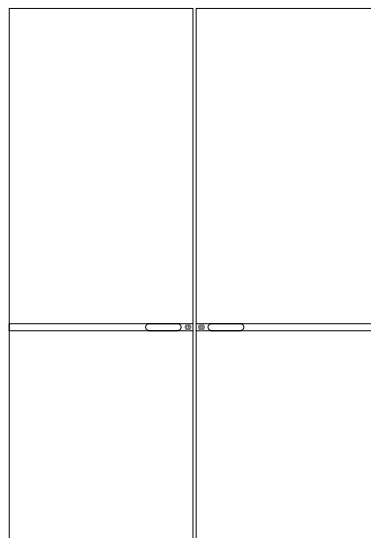

Change B (Open)

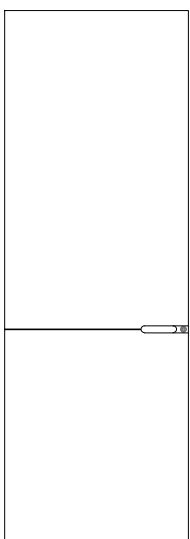

Change A (Single Open)

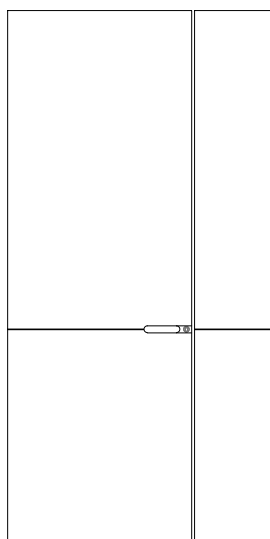

Change A (March 37)

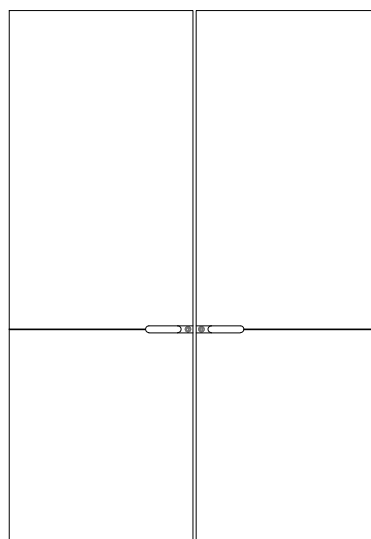

Change A (Open)

# Door fan combinationor

Single glass door

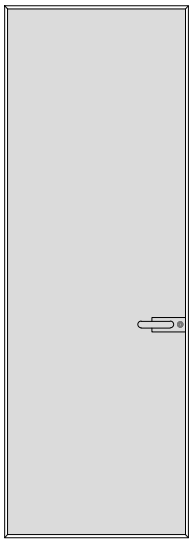

Turin single glass(single open)

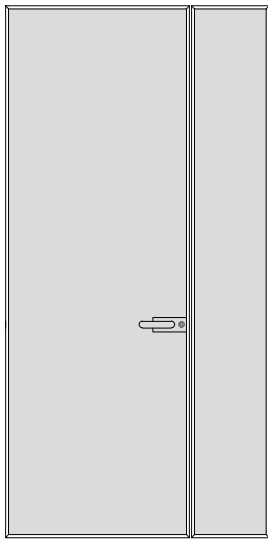

Turin Single Glass (Sanqi Gate)

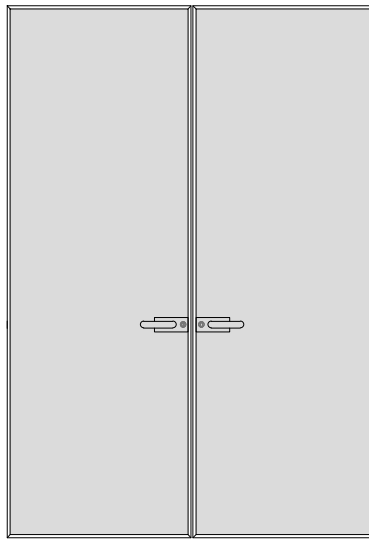

Turin single glass (open the door)

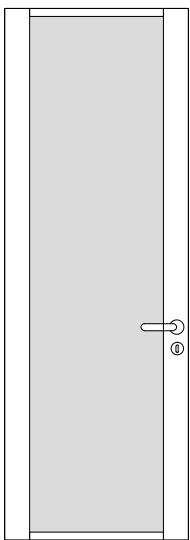

Rafael A (single)

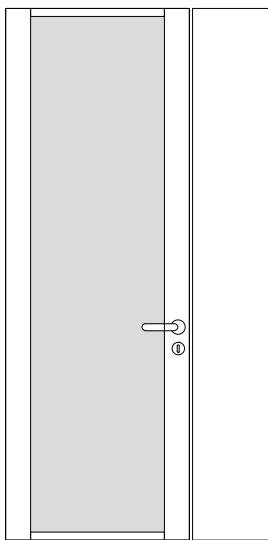

Rafael A (Sanqi Gate)

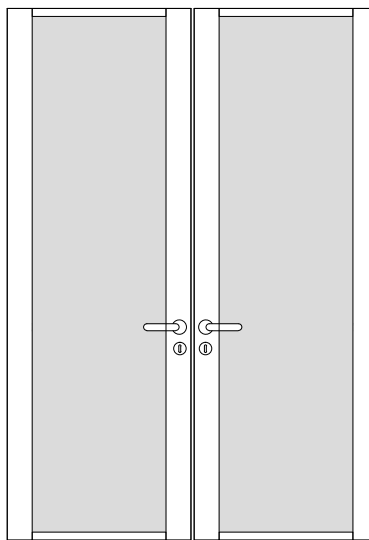

Rafael A (Open)

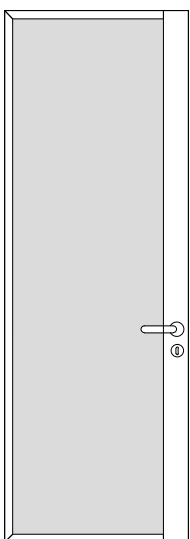

Rafael B (single)

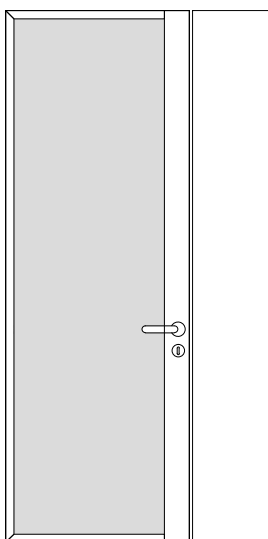

Rafael B (Sanqi Gate)

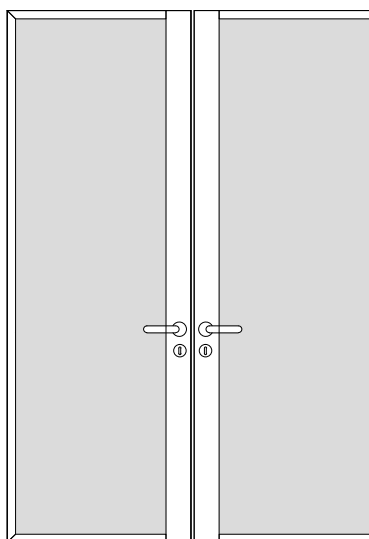

Rafael B (Open)

Tablet + grille door

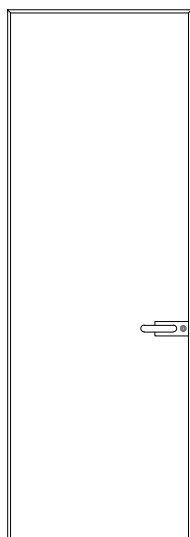

Turin tablet (single open)

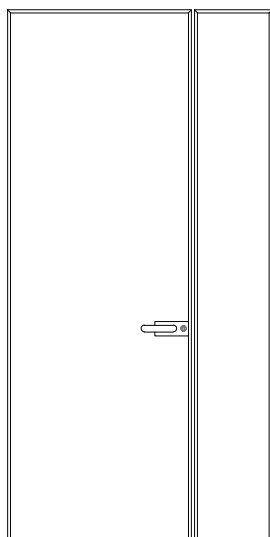

Turin tablet (Panax door)

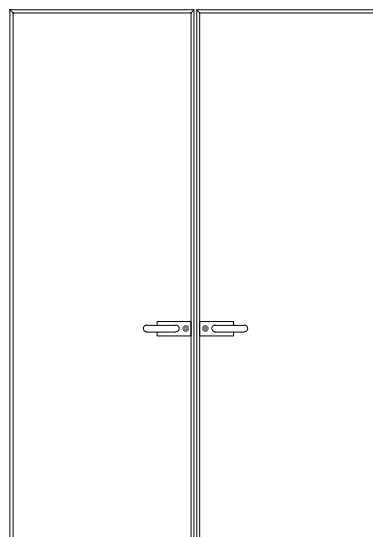

Turin tablet (opposite door)

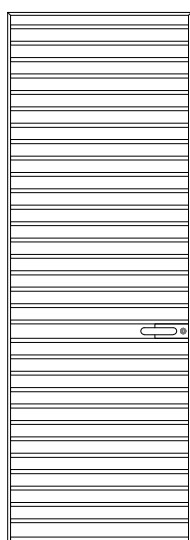

Turin Grille (single open)

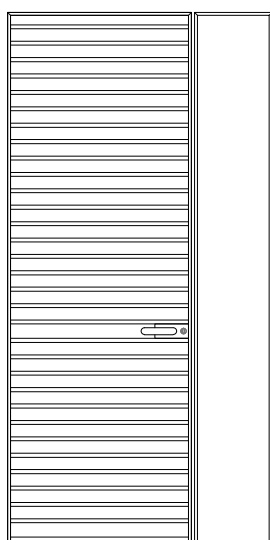

Turin Grille (Sanqi Gate)

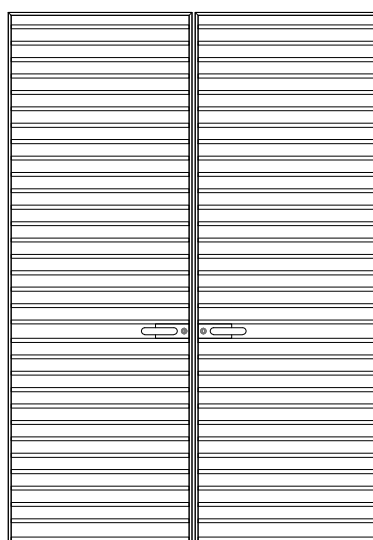

Turin Grille (opposite door)

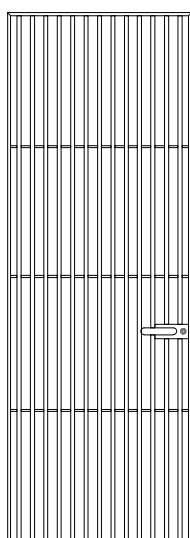

Turin Grille (single open)

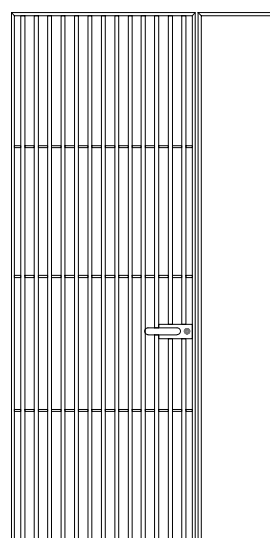

Turin Grille (Sanqi Gate)

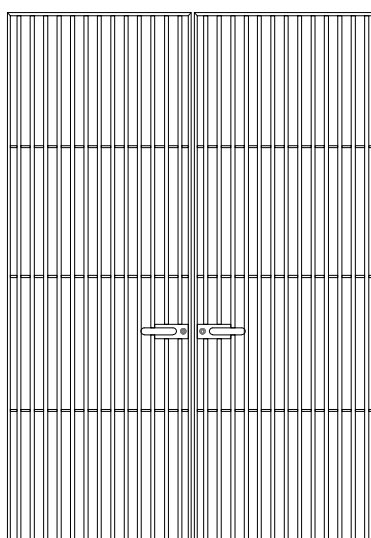

Turin Grille (opposite door)