

## ■ 特徵

- 引動器種類廣泛，且有動作位置可調整之設計 (如TM1701)
- 高開閉容量 (15A) ● 高精確度
- 廣泛操作速度範圍

## ■ 規格

### ● 額定值

額定電壓	非電感性負載(A)			電感性負載(A)			突入電流 (A)	
	電阻性負載		燈泡負載	電感性負載		馬達負載		
	NC	NO	NC	NO	NC	NO	NC	NO
125 VAC	15	3	1.5	15	5	2.5	30 以下	15 以下
250 VAC	15	2.5	1.25	15	3	1.5		
500 VAC	3	1.5	0.75	2.5	1.5	0.75		
8 VDC	15	3	1.5	15	5	2.5		
14 VDC	15	3	1.5	10	5	2.5		
30 VDC	6(2)	3	1.5	5	5	2.5		
125 VDC	0.4	0.4	0.4	0.05	0.05	0.05		
250 VDC	0.2	0.2	0.2	0.03	0.03	0.03		

### ● 特性

操作速度	0.01mm至1m/sec (柱塞型)
動作頻率	機械：240次/分 電氣：20次/分
接點電阻	15mΩ 以下 (初期)
絕緣電阻	100MΩ 以上 (在500VDC下)
耐電壓	非連續端子間： 1,000VAC, 50/60Hz, 持續1分鐘 載流零件和接地間： 2,000VAC, 50/60Hz, 持續1分鐘
振動	(* 10至20HZ) : 1.5mm雙振幅 誤動作耐久：10~55Hz
衝擊	機械耐久：1,000m/Sec <sup>2</sup> (約100G'S) 誤動作耐久：300m/Sec <sup>2</sup> (約30G'S)
使用周溫	汎用型：-25°C~+80°C 密封型：-15°C~+80°C
濕度	汎用型：最大85%RH 密封型：最大95%RH
使用壽命	機械：20,000,000次以上 電氣：500,000次以上
重量	約22至58g
保護構造	汎用型：IP00 密封型：IP62

- TM系列每一型式均具有焊接端子、螺絲端子與快速端子可供選擇
- 型號後面加A則為焊接端子，加C則為快速端子，空白則為螺絲端子

- 螺絲端子
- 焊接端子
- 快速端子

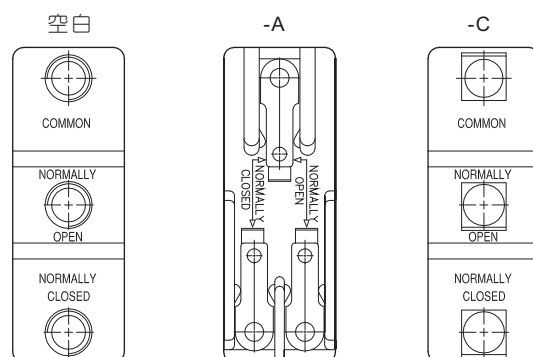

### ● 接點構成



### ● 動作特性

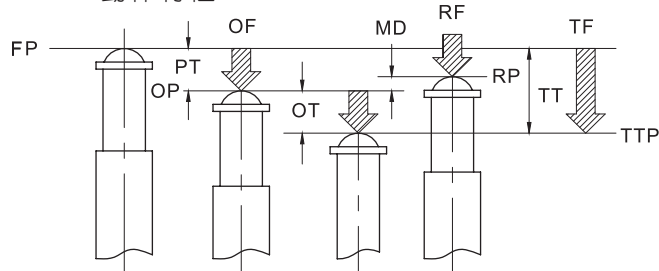

- OF: 動作所需之力
- RF: 回復力
- TF: 整個移動所需之力
- FP: 自由位置
- OP: 動作位置
- RP: 回復位置
- TTP: 整個移動之位置
- PT: 至動作為止之移動
- OT: 動作後之移動
- MD: 差距
- TT: 整個移動

## ■ 構造

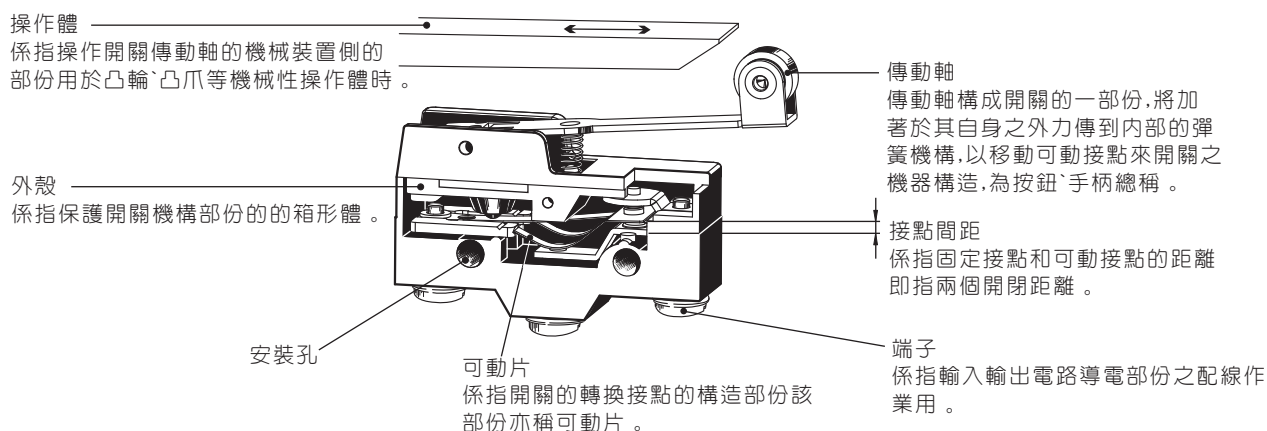

## 動作特性

型式	TM-1300	TM-1301	TM-1303	TM-1305	TM-1306	TM-1307	TM-1308	TM-1309
OF 最大	350g	300g	300g	350g	350g	350g	350g	350g
RF 最小	114g	50g	50g	114g	114g	114g	114g	114g
PT 最大	0.4mm	4mm	4mm	0.4mm	0.4mm	0.4mm	0.4mm	0.4mm
OT 最小	0.13mm	1.6mm	1.6mm	1.6mm	1.6mm	5.5mm	3.58mm	3.58mm
MD 最大	0.05mm	1.3mm	1.3mm	0.05mm	0.05mm	0.05mm	0.05mm	0.05mm
FP 最大		20.6mm	31.8mm					
OP	15.9±0.4mm	17.4±0.8mm	28.6±0.8mm	28.2±0.5mm	21.5±0.5mm	21.8±0.8mm	33.4±1.2mm	33.4±1.2mm

## 外觀和尺寸

### TM-1300

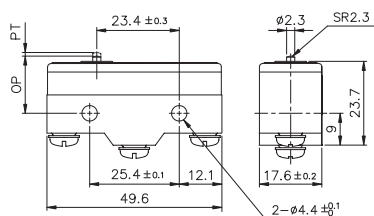

### TM-1306

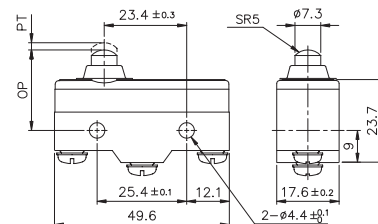

### TM-1301

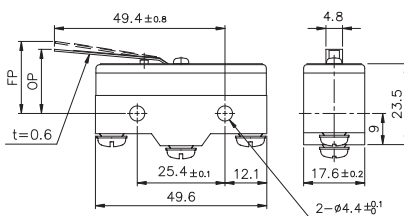

### TM-1307

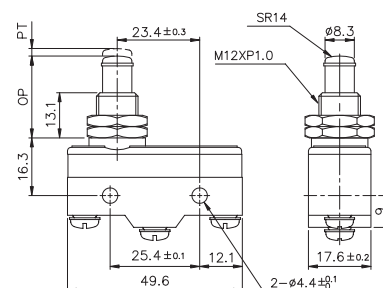

### TM-1303

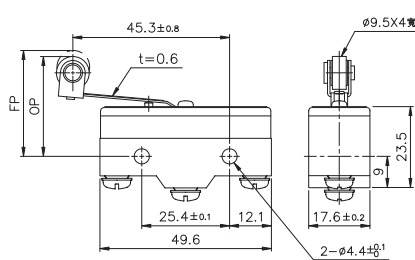

### TM-1308

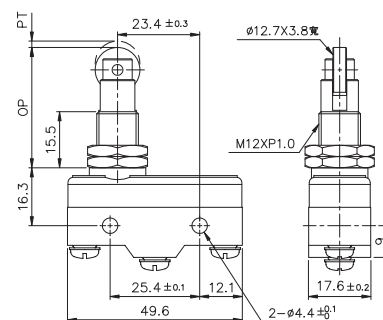

### TM-1305

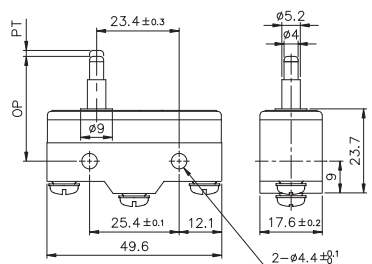

### TM-1309

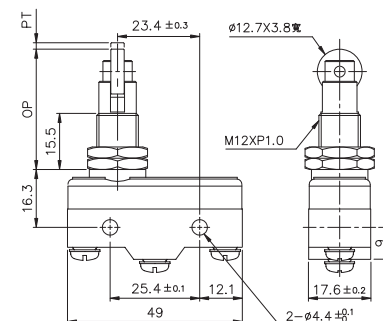

## 動作特性

型式	TM-1701	TM-1702	TM-1703	TM-1704	TM-1705	TM-1707	TM-1709	TM-1743
OF 最大	70g	160g	100g	160g	10g	170g	100g	160g
RF 最小	14g	28g	22g	42g	3g	42g	21g	42g
PT 最大	10mm	5mm	7.1mm	2.7mm	20mm	2.7mm	7.3mm	2.7mm
OT 最小	5.6mm	2mm	4mm	2.4mm	5.6mm	2.4mm	4mm	2.4mm
MD 最大	1.27mm	1mm	1.02mm	0.5mm	4mm	0.5mm	1.6mm	0.5mm
FP 最大	28.2mm	24.8mm	36.5mm	32.5mm		33.3mm	47.5mm	43.6mm
OP	19±0.8mm	19±0.4mm	30.2±0.8mm	30.2±0.4mm	19±0.8mm	31±0.4mm	41.2±0.8mm	41.3±0.8mm

## 外觀和尺寸

TM-1701

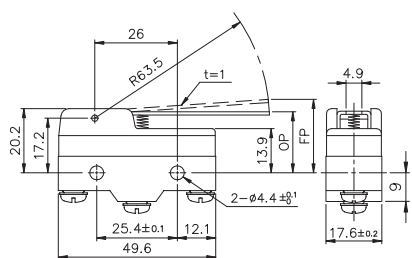

TM-1705

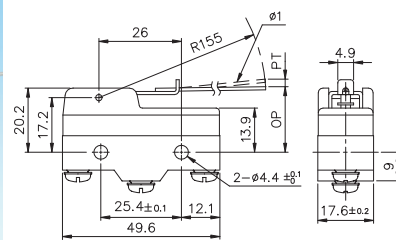

TM-1702

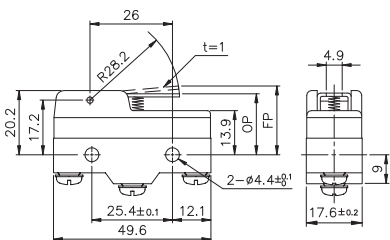

TM-1707

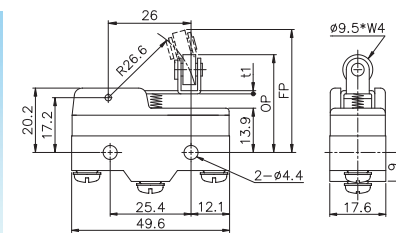

TM-1703

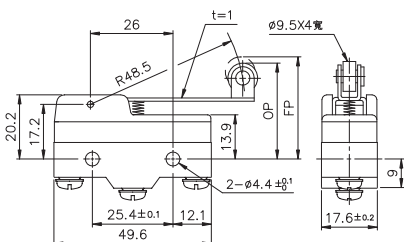

TM-1709

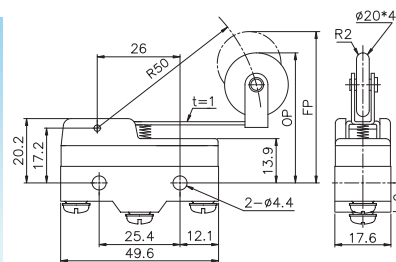

TM-1704

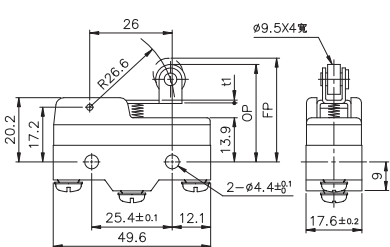

TM-1743

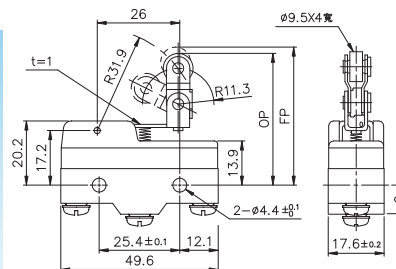

## 動作特性

型式	TM-1401	TM-1501
OF 最大	500g	600g
RF 最小	170g	300g
PT 最大	5mm	3mm
OT 最小	12.7mm	6mm
MD 最大	2.2mm	2mm
FP 最大	44.5±1.6mm	41±1.6mm
OP	40.4±1.6mm	40.4±1.6mm

## 外觀和尺寸

### TM-1401

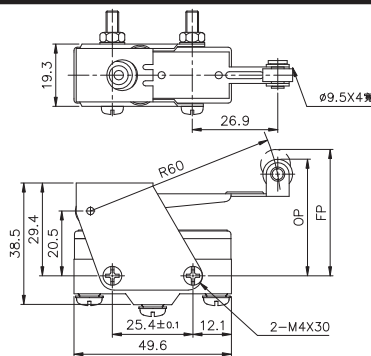

### TM-1501

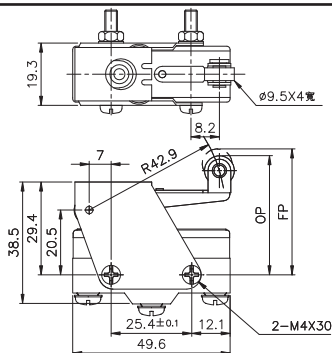

### TAP-Y

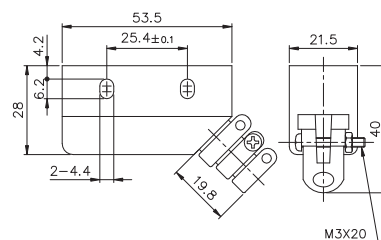

### TAP-Z

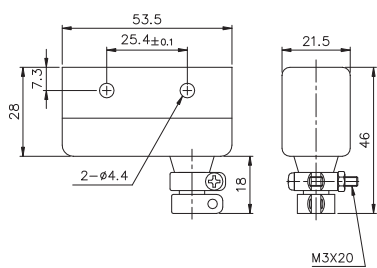

### TAP-X

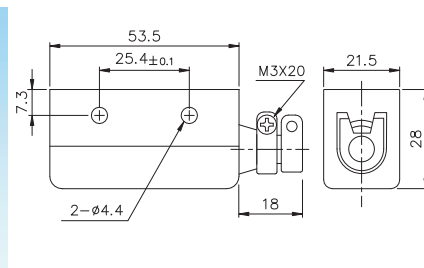

## 負載連結

一個開關的接點上不可連結不同極、不同種的電源。  
不同極的連結

電源會有短路現象。

不適當

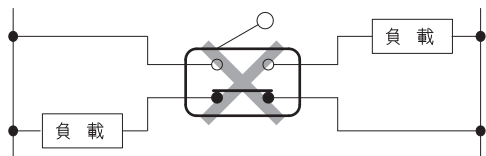

適當

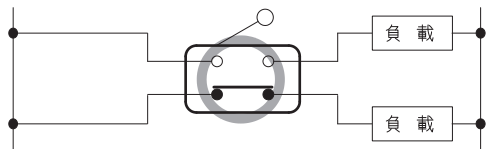

負載連接在相同側

不能在兩個接點上同時連結負載,因會造成絕緣體性能的提早損壞與減低使用壽命。

## 不同種電源的連結

直流電與交流電會有混合連結的現象。

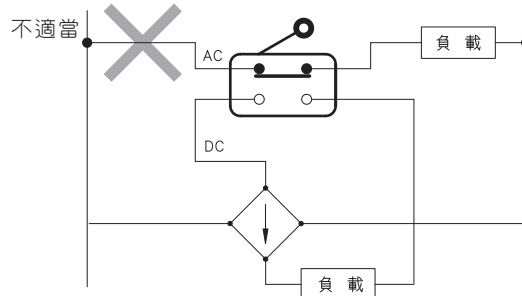

接點之間務必避免有電壓的回路,否則將會引發熔著毀損。

不適合

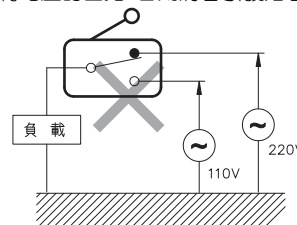

## 接點保護回路

之所以採用接點保護回路之原因,乃在於延長接點之壽命、防止雜音及因電弧而形成之碳化物,以減少硝酸之生成。使用不當時會變成反效果。採用接點保護回路時,負載的動作時間會緩慢。

## ■ 特徵

- 引動器種類廣泛，且有動作位置可調整之設計 (如TM1701)
- 高開閉容量 (20A) ● 高精確度
- 廣泛操作速度範圍

## ■ 規格

### ● 額定值

額定電壓	非電感性負載(A)		電感性負載(A)				突入電流 (A)			
	電阻性負載		燈泡負載		電感性負載				馬達負載	
	NC	NO	NC	NO	NC	NO	NC	NO	NC	NO
125 VAC	20		7.5		20		12.5		30 以下	15 以下
250 VAC	20		7.5		20		8.3			
500 VAC	5		2		3		2			
8 VDC	20	3	1.5	20		12.5				
14 VDC	20	3	1.5	15		12.5				
30 VDC	6(2)	3	1.5	5		5				
125 VDC	0.4	0.4	0.4	0.05		0.05				
250 VDC	0.2	0.2	0.2	0.03		0.03				

### ● 特性

操作速度	0.01mm至1m/sec (柱塞型)
動作頻率	機械：240次/分 電氣：20次/分
接點電阻	15mΩ 以下 (初期)
絕緣電阻	100MΩ 以上 (在500VDC下)
耐電壓	非連續端子間： 1,000VAC, 50/60Hz, 持續1分鐘 載流零件和接地間： 2,000VAC, 50/60Hz, 持續1分鐘
振動	(*10至20HZ)：1.5mm雙振幅 誤動作耐久：10~55Hz
衝擊	機械耐久：1,000m/Sec <sup>2</sup> (約100G'S) 誤動作耐久：300m/Sec <sup>2</sup> (約30G'S)
使用周溫	汎用型：-25°C~+80°C (但不結冰) 密封型：-15°C~+80°C (但不結冰)
濕度	汎用型：最大85%RH 密封型：最大95%RH
使用壽命	機械：1,000,000次以上 電氣：500,000次以上
重量	約22至58g
保護構造	汎用型：IP00 密封型：IP62

- TM系列每一型式均具有焊接端子、螺絲端子與快速端子可供選擇
- 型號後面加A則為焊接端子，加C則為快速端子，空白則為螺絲端子

- 螺絲端子
- 焊接端子
- 快速端子

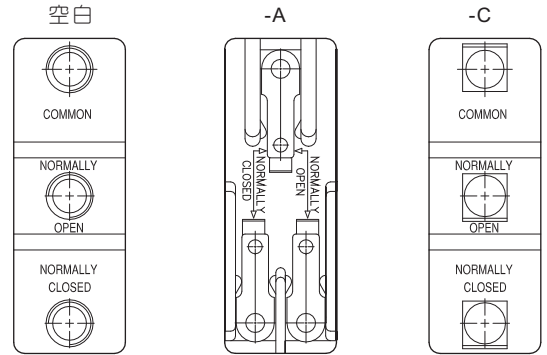

### ● 接點構成

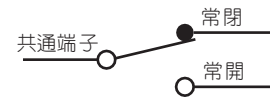

### ● 動作特性

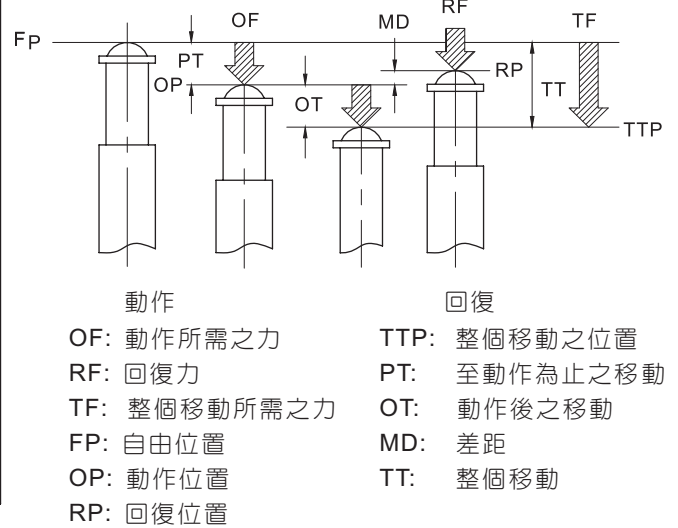

## ■ 構造

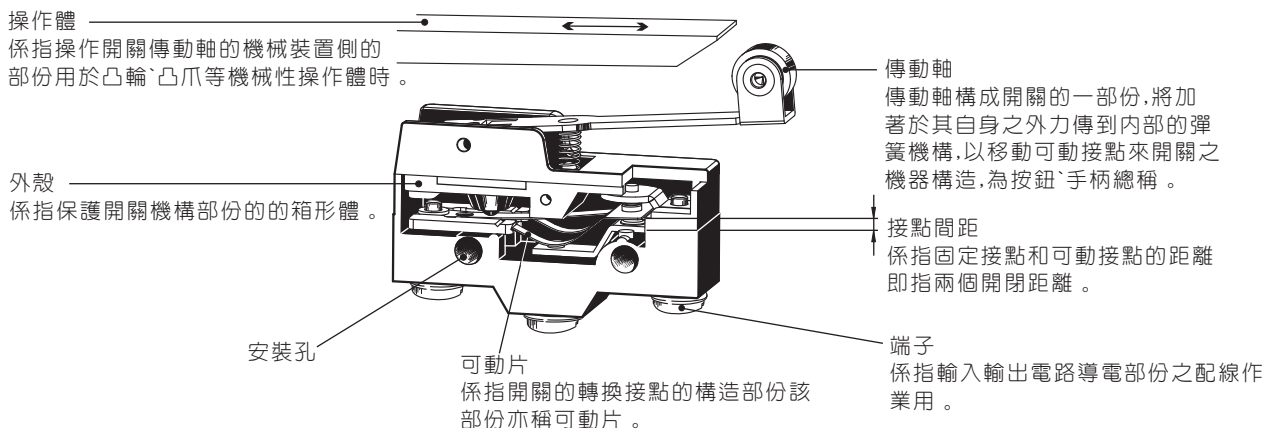



## 動作特性

型式	TM-1300-2	TM-1301-2	TM-1303-2	TM-1305-2	TM-1306-2	TM-1307-2	TM-1308-2	TM-1309-2
OF 最大	650g	350g	350g	650g	650g	650g	650g	650g
RF 最小	200g	50g	50g	200g	200g	200g	200g	200g
PT 最大	0.7mm	4mm	4mm	0.7mm	0.7mm	0.7mm	0.7mm	0.7mm
OT 最小	0.13mm	1.6mm	1.6mm	1.6mm	1.6mm	5.5mm	3.58mm	3.58mm
MD 最大	0.2mm	1.3mm	1.3mm	0.05mm	0.2mm	0.2mm	0.2mm	0.2mm
FP 最大		20.6mm	31.8mm					
OP	15.9±0.4mm	17.4±0.8mm	28.6±0.8mm	28.2±0.5mm	21.5±0.5mm	21.8±0.8mm	33.4±1.2mm	33.4±1.2mm

## 外觀和尺寸

### TM-1300-2

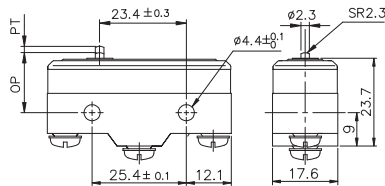

### TM-1306-2

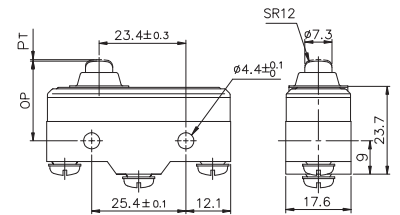

### TM-1301-2

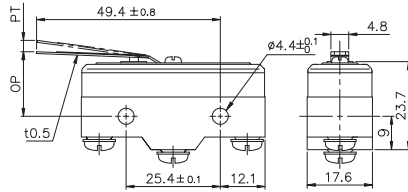

### TM-1307-2

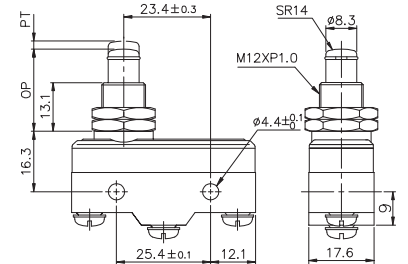

### TM-1303-2

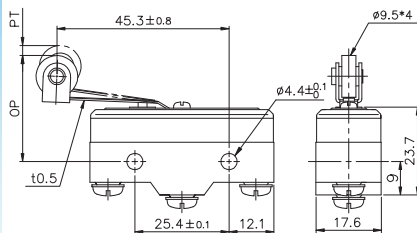

### TM-1308-2

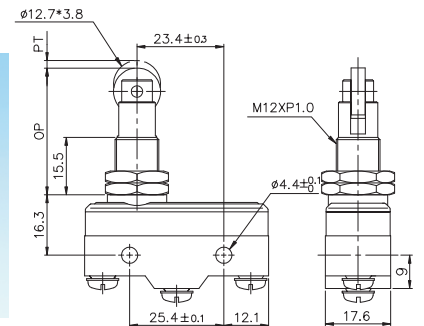

### TM-1305-2

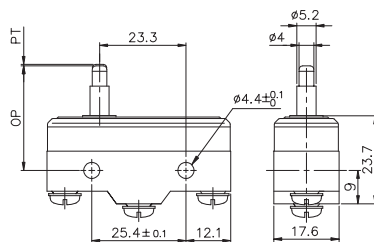

### TM-1309-2

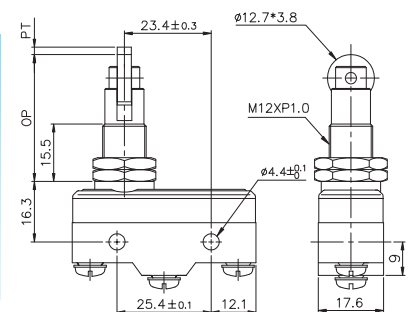

## 動作特性

型式	TM-1701-2	TM-1702-2	TM-1703-2	TM-1704-2	TM-1705-2	TM-1707-2	TM-1709-2	TM-1743-2
OF 最大	80g	160g	120g	180g	20g	170g	70g	180g
RF 最小	14g	42g	22g	42g	5g	42g	34g	42g
PT 最大	10mm	6.5mm	7.1mm	2.7mm	20mm	2.7mm	6.3mm	2.7mm
OT 最小	5.6mm	1.2mm	4mm	2.4mm	5.6mm	2.4mm	6mm	2.4mm
MD 最大	1.27mm	1.2mm	1.02mm	0.5mm	3.5mm	0.5mm	0.74mm	0.5mm
FP 最大	28.2mm		36.5mm	32.5mm		34mm	47.5mm	43.6mm
OP	19±0.8mm	19±0.8mm	30.2±0.8mm	30.2±0.4mm	19±0.4mm	31±0.4mm	41.2±0.8mm	41.3±0.8mm

## 外觀和尺寸

### TM-1701-2

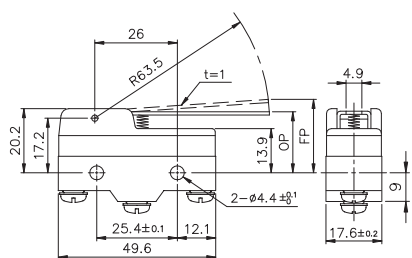

### TM-1705-2

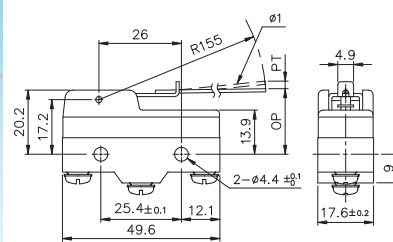

### TM-1702-2

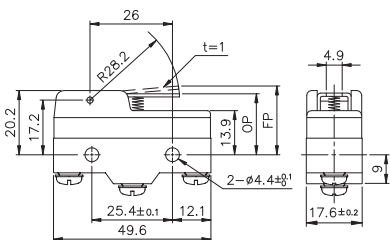

### TM-1707-2

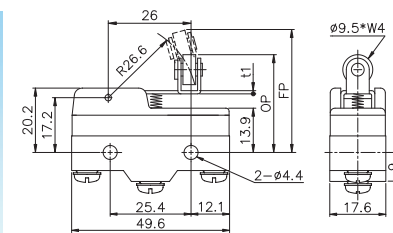

### TM-1703-2

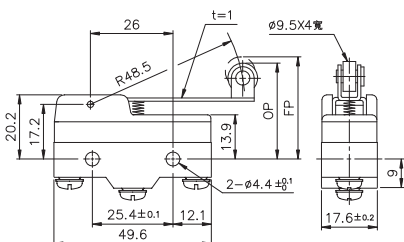

### TM-1709-2

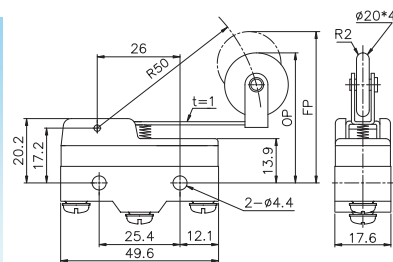

### TM-1704-2

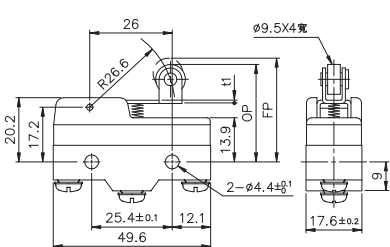

### TM-1743-2

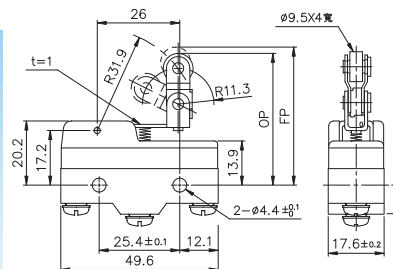

本系列為完全密封型微動開關,防油、防水、防塵適用於較差之環境。(端子部份則為裸露)

## 動作特性

型式	TM-1300-1	TM-1301-1	TM-1303-1	TM-1305-1	TM-1306-1	TM-1307-1	TM-1308-1	TM-1309-1
OF 最大	500g	400g	400g	500g	500g	500g	500g	500g
RF 最小	114g	50g	50g	114g	114g	114g	114g	114g
PT 最大	0.4mm	4mm	4mm	0.4mm	0.4mm	0.4mm	0.4mm	0.4mm
OT 最小	0.13mm	1.6mm	1.6mm	1.6mm	1.6mm	5.5mm	3.58mm	3.58mm
MD 最大	0.05mm	1.3mm	1.3mm	0.05mm	0.05mm	0.05mm	0.05mm	0.05mm
FP 最大		20.6mm	31.8mm					
OP	15.9±0.4mm	17.4±0.8mm	28.6±0.8mm	28.2±0.5mm	21.5±0.5mm	21.8±0.8mm	33.4±1.2mm	33.4±1.2mm

## 外觀和尺寸

### TM-1300-1

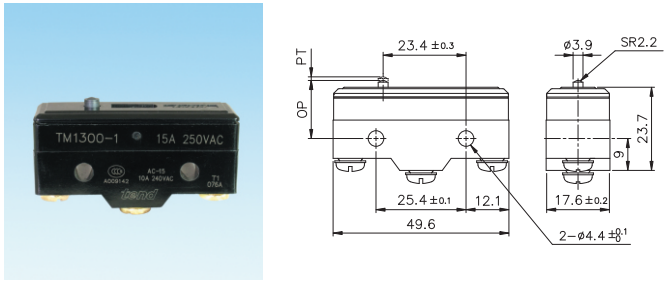

### TM-1306-1

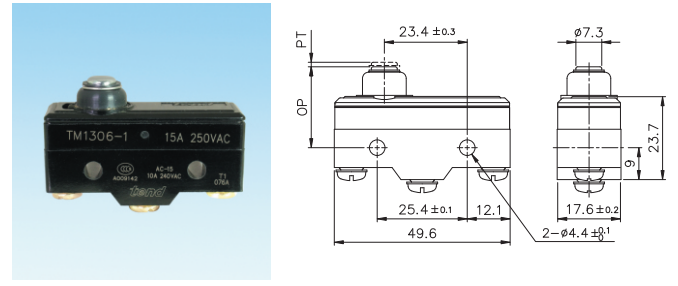

### TM-1301-1

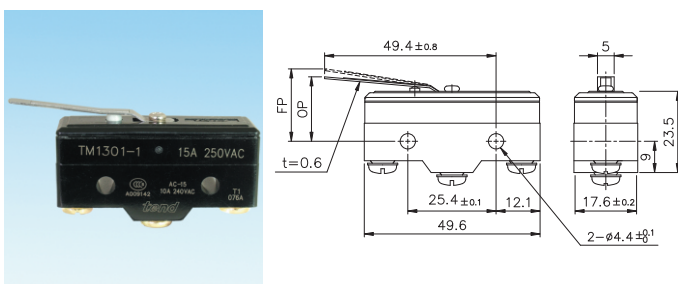

### TM-1307-1

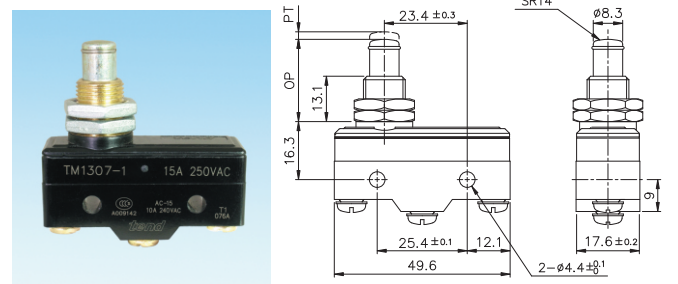

### TM-1303-1

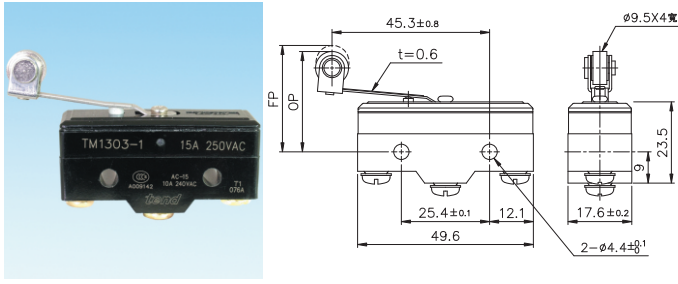

### TM-1308-1

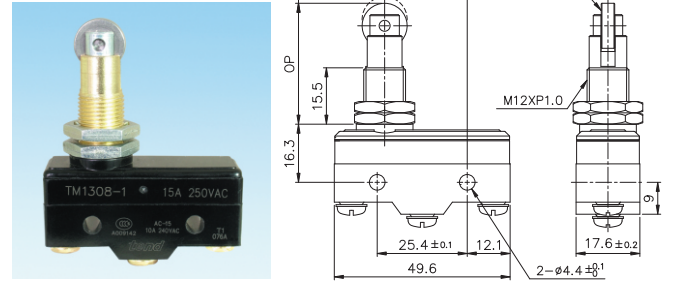

### TM-1305-1

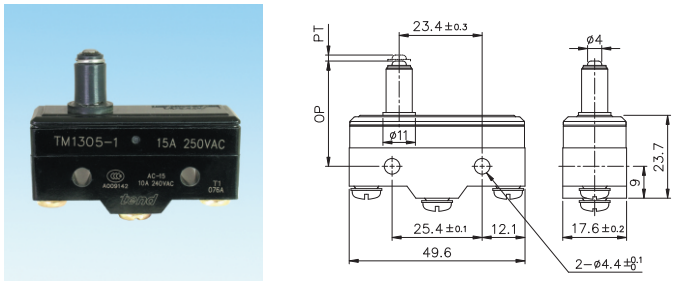

### TM-1309-1

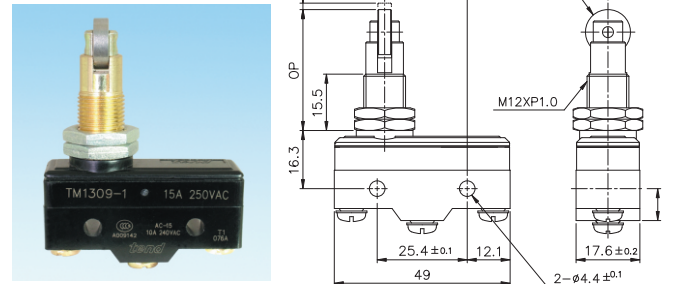



## 動作特性

型式	TM-1701-1	TM-1702-1	TM-1703-1	TM-1704-1	TM-1705-1	TM-1707-1	TM-1709-1	TM-1743-1
OF 最大	100g	190g	130g	190g	40g	200g	130g	190g
RF 最小	14g	28g	21g	42g	3g	42g	21g	50g
PT 最大	10mm	5mm	7.1mm	2.7mm	20mm	2.7mm	7.3mm	2.7mm
OT 最小	5.6mm	2mm	4mm	2.4mm	5.6mm	2.4mm	4mm	2.4mm
MD 最大	2mm	1mm	1.6mm	0.8mm	4mm	0.5mm	1.6mm	0.8mm
FP 最大	28.2mm	25mm	36.5mm	32.9mm		33.3mm	47.5mm	43.6mm
OP	19±0.8mm	19±0.8mm	30.2±0.8mm	30.2±0.4mm	19±0.8mm	31±0.4mm	41.2±0.8mm	41.3±0.8mm

## 外觀和尺寸

TM-1701-1

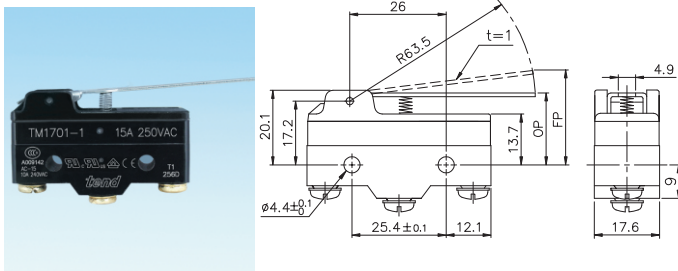

TM-1705-1

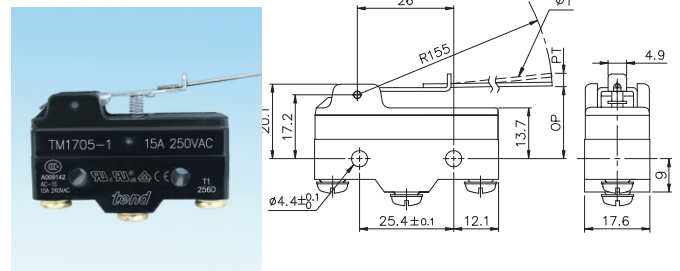

TM-1702-1

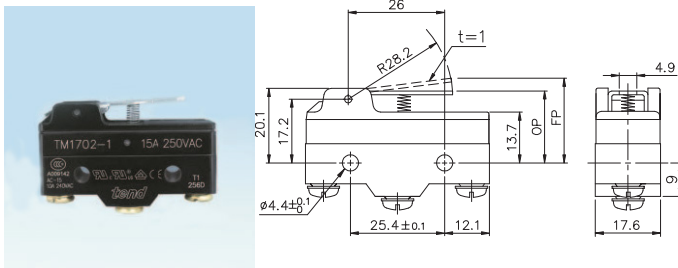

TM-1707-1

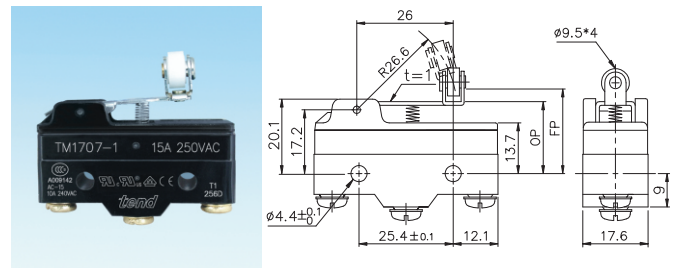

TM-1703-1

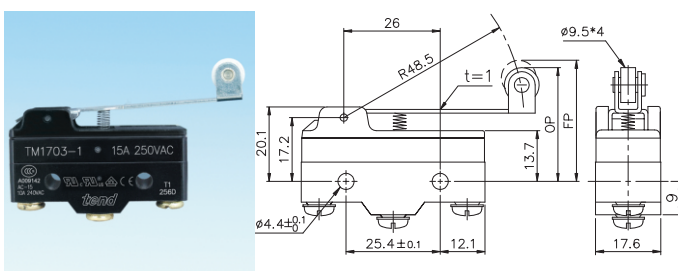

TM-1709-1

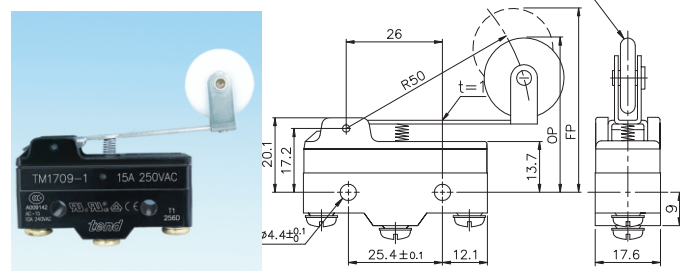

TM-1704-1

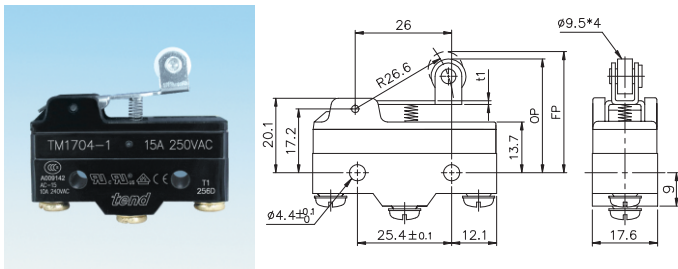

TM-1743-1

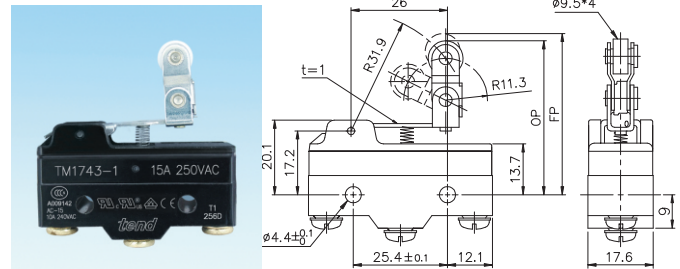

## ■ 特徵

- 與TEND TM型微動開關有相同之外型
- 在接點機構內藏一小型永久磁鐵,可吹離所產生之火花,並且有效消除之
- 關閉DC迴路用之理想開關

## ■ 規格

- 額定值

額定電壓 (V)	非電感性負載(A)			電感性負載(A)			
	電阻性負載		燈泡負載	電感性負載		馬達負載	
	NC	NO	NC	NO	NC	NO	NC
8 VDC	15	3	1.5	15	15	5	2.5
14 VDC	15	3	1.5	15	10	5	2.5
30 VDC	15	3	1.5	10	10	5	2.5
125 VDC	10	3	1.5	7.5	6	5	2.5
250 VDC	3	3	1.5	2	1.5	2	1.5

註: 1. 電感性負載: 功率因素 = 0.4(AC), 時間常數7ms以下(DC)

2. 燈泡負載之突入電流為穩定電流之10倍。

馬達負載為穩定電流之6倍。

## ■ 特性

操作速度	0.1mm~1m/s
動作頻率	機械: 240次/分以下 電氣: 20次/分以下
接點電阻	15mΩ以下
絕緣電阻	100MΩ以上 (在500VDC下)
耐電壓	1,500VAC, 50/60Hz, 持續1分鐘
振動	誤動作耐久: 10~55Hz, 15mm雙振幅
衝擊	機械耐久: 1,000m/s <sup>2</sup> 以上 (約100G以上) 誤動作耐久: 300m/s <sup>2</sup> 以上 (約30G以上)
使用周溫	-25~+80°C
濕度	最大85%RH
使用壽命	機械: 1,000萬次以上 電氣: 10萬次以上
重量	約27g~36g
保護構造	汎用型: IP00 密封型: IP62

## ■ 接線方式

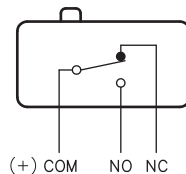

## ■ 外觀和尺寸

### TMD-1701

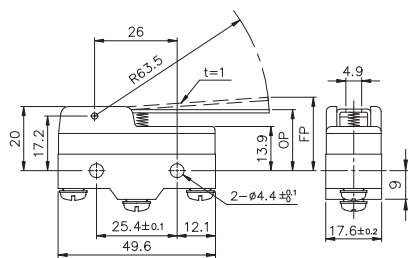

### TMD-1703

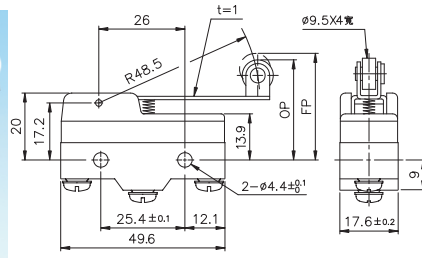

### TMD-1702

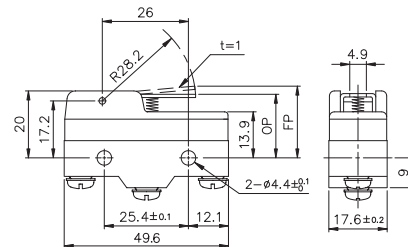

### TMD-1704

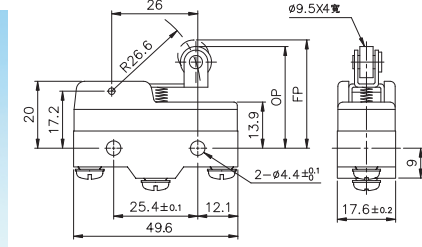

## ■ 動作特性

型式	TMD-1701	TMD-1702	TMD-1703	TMD-1704
OF 最大	110gf(1.08N)	250gf(2.45N)	145gf(1.42N)	220gf(2.16N)
RF 最小	14gf(0.14N)	32gf(0.31N)	21gf(0.21N)	35gf(0.34N)
OT 最小	4.8mm	2.1mm	4mm	2.4mm
MD 最大	3.9mm	1.7mm	3mm	1.7mm
FP 最大	34.6mm	25.5mm	40.5mm	37.1mm
OP	19.8±0.8mm	19.8±0.4mm	32.2±0.8mm	32.2±0.8mm